



Dendrimer Dipole Excitation: A Different Terahertz Era that is Often Overlooked

Anis Rahman*

Applied Research & Photonics, Inc., 470 Friendship Road, Suite 10, Harrisburg, PA 17111, USA

ABSTRACT

This paper presents a dendrimer dipole excitation-based Terahertz Radiation (T-ray) generation technique. Here an ordinary dendrimer is converted to electro-optic dendrimer by engineering three of the possible six Critical Nano Scale Design Parameters (CNDPs). A time-domain spectrometer circuit was designed and used for measuring the T-ray power generated by the source. The long-term stability of the same T-ray source was measured for ~200 Ks. It was found that the source exhibits very good stability over the period of more than 125 Ks. This outstanding stability over a long period is achieved by the engineered electro-optic dendrimer whose properties have been optimized to function as a non-absorbing system and not prone to photo-degradation over a long period. This source was used to design a time-domain spectrometer that was utilized to characterize molecular identities of a number of molecular systems.

Keywords: Dendrimer dipole excitation; T-ray source; Critical nano-scale design parameter; Long-term power stability

INTRODUCTION

In a recent article Dr. Donald Tomalia mentioned that “Essentially, all new disruptive discoveries/technologies begin with a predictable period of disbelief and rejection. In some cases, progress or delay of acceptance is determined by access to special experimental instrumentation or emerging new characterization methodologies for unequivocal confirmation. More often than not, acceptance is simply determined by a handful of unique individuals who possess the curiosity, technical insights and skill sets to obtain the compelling results that overcome even the most severe critics. Such was the case for the discovery of dendrimers/dendritic polymers” [1].

The above is true for the field of electro-optic Dendrimer-based Terahertz (T-ray) research as well. While there is a significant body of research papers being published; and the number is on the increase at a significant rate, however, a great majority of the papers are dealing with a limited terahertz window, based on whatever instrumentation is available to them. Yes, the terahertz field is still mostly full of experimental investigation of various materials and related activities.

The legacy technology for T-ray generation uses the Auston switch. Dave Auston’s discovery of first terahertz generation has been eloquently described in an introductory article of the IEEE Transactions on Terahertz Science and Technology, the first volume (no. 1) by Peter Siegel [2]. Auston found a way to use a photo switch

excited by a fast laser to generate terahertz that spanned up to a few THz which later came to be known as the Auston Switch. Auston’s pioneering work initiated a new era of science and technology for many investigations of materials’ properties that owes a great deal to the field of T-rays.

The difficulty with the photo switch technology is that it depends entirely on the fast pulsed laser, usually a femto-second pulsed laser. The femto-second pulsed laser is an emerging technology by itself. Its output power cannot be cranked up just by an electric input and many femto-lasers suffer from stability issue. The T-ray output power is only a fraction of the power input from the femto-second pump laser due to the poor conversion efficiency of inorganic materials. Hence, usually a low output power in the microwatt range is available from the auston switch. The T-ray band width of the photo switch is dependent on the design parameters, dielectric, and electro-optic properties of the substrate on which the photo switch is fabricated. Therefore, though it is the first of its kind, it offers a narrow observation window and consequently, its application span remains limited. This in turn, limits the scope of commercialization.

Later, Robert F. Carl, Jr. (Chemistry Nobel Laurate, 1996) group [3] demonstrated in 1993 that two ordinary diode lasers can be used to generate T-ray, what they termed as the far-IR radiation, by the Difference Frequency Generation (DFG) in a suitable crystal such as GaAs [3]. This eliminates the need of a femto-laser; however,

Correspondence to: Anis Rahman, Chief Technology Officer and President Applied Research & Photonics, Inc., 470 Friendship Road, Suite 10, Harrisburg, PA 17111, Tel: +1-717-623-8201, E-mail: a.rahman@arphotonics.net

Received: 05-Jan-2022, Manuscript No. JMST-22-15395; **Editor assigned:** 07-Jan-2022, PreQC No. JMST-22-15395(PQ); **Reviewed:** 21-Jan-2022, QC No. JMST-22-15395; **Revised:** 24-Jan-2022, Manuscript No. JMST-22-15395(R); **Published:** January 31, 2022, DOI: 10.35248/2155-9589-12.2.264.

Citation: Rahman A (2022) Dendrimer Dipole Excitation: A Different Terahertz Era that is often Overlooked. J Membr Sci Technol. 12:264.

Copyright: © 2022 Rahman A. This is an open-access article distributed under the terms of the Creative Commons Attribution License, which permits unrestricted use, distribution, and reproduction in any medium, provided the original author and source are credited.

their data showed that the output power is still in nano watts. This is because like all inorganic materials, GaAs has a very low electro-optic coefficient, hence very low pump-to-T-ray conversion efficiency. Since inorganics are mostly absorbing materials, a higher pump power only heat up the target, resulting in the conversion efficiency to reach saturation very rapidly.

The electro-optic route for terahertz generation

The Electro-Optic (EO) Route for Terahertz (THz) generation, especially *via* an organic/polymeric route offers many advantages. First, in this case the pump-THz conversion is not limited either by emission saturation or heat dissipation. Second, the conversion efficiency is not restricted by the inorganic lattice which is fixed. Third, significantly higher output power and higher bandwidth is obtainable. For the EO route, the main mechanisms include: EO Rectification (EOR), Difference Frequency Generation (DFG), optical parametric oscillation, and a newly discovered mechanism of Dendrimer Dipole Excitation (DDE). Of these, the EOR again depends on a femto-second pulsed laser (femto-laser) where an ultra-fast laser pulse is introduced into the lattice of an electro-optically active material; the lattice acts as a rectifier to convert the very high frequency derived from the femto-laser to a relatively lower frequency pulse that falls in the terahertz range. This is so-called as electro-optic rectification effect. The rectification method usually uses a femto-laser at 800 nm wavelength. The difficulty here is that, not only the process is depended on the availability of a femto-laser, but two vital parameters of the terahertz radiation, the output power and the terahertz range, are completely dependent on the characteristics of the femto-laser. As such, only low T-ray power has been produced and a range of a few terahertz has been possible.

Also, the output power is always pulsed because of the pulsed nature of the femto-laser input pulse train. Because of its low available power and low THz range (~ 5 THz) it is difficult to uniquely characterize many materials system. A source capable of providing higher power and wider THz range in a compact form, therefore, is important for spectroscopy applications.

The above brief review reveals that the inorganics route is the more established (legacy) way for T-ray generation, but it provides a source only of a few tens of microwatts over a narrow bandwidth of a few THz. Maximum bandwidth achieved *via* the inorganics route to date is about 6 THz. Thus, the instruments based on such a source suffer from limitations of a narrow window of observation and a very limited material could be probed because of its low available output power. This also explains the reason for most of the work reported in the literature deal with a rather limited scope.

Consequently, a vast majority of the terahertz community to date, however, has focused their terahertz activities based on the instruments that are available in the marketplace. The first terahertz instruments commercialized by a couple of companies are built around the Auston switch technology discussed above and hence incorporates the limitations of low power and low bandwidth; hence the performance limitations. Low power limits the probing capacity for a diverse group of materials including the semiconductors and nano-materials. Low bandwidth limits the window observation over only a part of the entire terahertz regime. So, a better T-ray source is needed for harnessing the full capabilities of the T-ray technology. This has been a topic of discussion in various forums. In a personal email to the author, Professor Robert F. Curl, Jr. indicated that, "...

progress." Robert F Curl won the Nobel Prize in Chemistry for the discovery of the Bucky Ball structure (aka Fullerene, or C₆₀) [4].

A better t-ray source

At ARP, a team of researchers started the T-ray research in or around 2005 following a meeting with a DARPA program manager who was kind to emphasize the importance of a Continuous Wave (CW) terahertz source (that did not exist), since everything else out there was pulsed and dependent on a femto-second pulsed laser for T-Ray generation. "If an alternative for the expensive femto-second pulsed laser technology was available," the program manager and other experts present in that meeting mentioned, "that would be important for much scientific advancement." Fortunately, we had a solution in mind and so we added one more task to our list. This, subsequently, gave rise to a new physical mechanism what is termed as the "dendrimer dipole excitation," for T-ray generation [2]. Here an ordinary dendrimer molecule is engineered into an electro-optic dendrimer for creating a higher electro-optic coefficient material or, a high $\chi^{(2)}$ material, $\chi^{(2)}$ (Chi-two) being the second order susceptibility tensor. This high power, high bandwidth T-Ray source derived from the electro-optic dendrimer was reduced to practice *via* a new generation of T-ray instruments from ARP (see <http://arphotronics.net>).

Electro-optic dendrimer

Ordinary dendrimer is not an electro-optic material because its Electro-Optic Coefficient (EOC) will be zero, just like any amorphous material. So, some molecular engineering is necessary for obtaining an Electro-Optic (EO) dendrimer from an ordinary dendrimer. The first EO dendrimer was reported by the author in a SPIE conference which began the era of a new branch of dendrimer application in photonics. Let us outline some details of the engineering for converting an ordinary dendrimer into EO dendrimer.

The basic steps are (1) Doping the dendrimer with another molecule that will help creating the charge centers which, along with the charges of the dendrimer itself, will create a dipole population, as depicted in Figure 1. This step is done in the liquid phase, which is a big advantage compared to doping an inorganic material such as silicon. (2) Create a structure for device fabrication out of this doped dendrimer. This can be a waveguide, a film, or another structure. (3) Finally, the dipoles created in the previous step must be aligned for breaking the Centro-symmetry. That is, even though the doping process with a chromophore creates a population of charge-centers, and hence populations of dipoles, these dipoles are randomly oriented (Figure 1). The net electro-optic coefficient, i.e., the sum of all dipole moment vectors, is therefore, zero, because of the random orientation of each dipole. The process of aligning the dipole moments to a uniaxial EO material is called poling, as depicted in Figure 2. This step creates an EO dendrimer from the ordinary dendrimer from which a T-ray emitter is made.

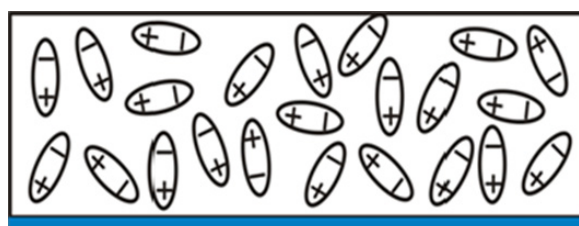

Figure 1: Sketch of dipole moments created *via* doping a dendrimer with a suitable chromophore.

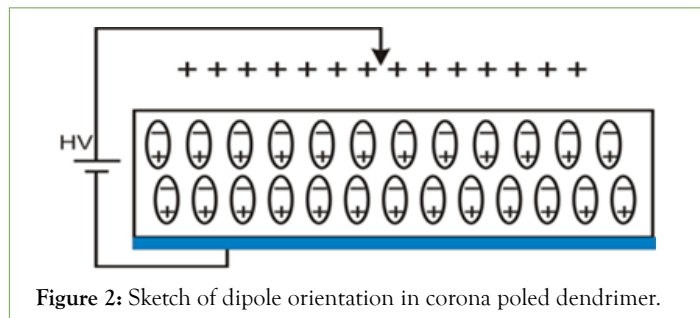

Figure 2: Sketch of dipole orientation in corona poled dendrimer.

Dendrimer Dipole Excitation (DDE): A new mechanism for t-ray generation

Pioneering work by Rahman and Tomalia [5], Dalton et al. [6], Tomalia [7], and others [8] has shown that modification of functionality and architecture of certain dendritic, soft super atoms (i.e., dendrimers) has produced a wide range of unprecedented and enhanced Non-Linear Optical (NLO) properties. These new emerging Non-Linear Optical (NLO) properties directed by Critical Nano Scale Design Parameters (CNDPs) engineering [8] have been exploited for high power and higher bandwidth T-ray generation [9]. This earlier dendritic NLO effort [9] provided the groundwork and basis for more recent work by Rahman, Tomalia, et al. [8-10], who applied these principles to traditional dendritic architectures such as PAMAM dendrimers. It was found that an engineering of only three the six CNDPs described in Figure 3 provided new emerging hyper-polarizable dendrimer properties. It was also demonstrated, that doping ordinary PAMAM dendrimers with certain NLO dyes created “site isolated interior chromophores” within the dendrimer interiors, as described before. Subsequent electro-optic poling of these modified dendrimers produced hyper-polarizable substrates exhibiting high Electro-Optic (EO) coefficients ranging from ~130 pm/V at 633 nm to ~90 pm/V at 1553 nm [11].

The basic mechanism of DDE is explained in Figure 4 and Figure 5 exhibits an energy level diagram for a broadband T-ray emission via the DDE mechanism. Precise energy level calculation is possible and should be a theoretical exercise. It is obvious to recognize that the terahertz range of the DDE emitter can be tuned by choosing an appropriate doping species, and the output T-ray power may also be tuned by two factors: Doping concentration and the pump power.

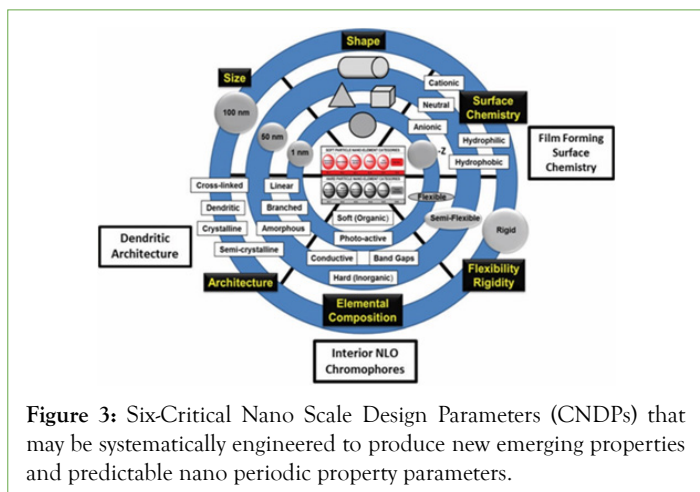

Figure 3: Six-Critical Nano Scale Design Parameters (CNDPs) that may be systematically engineered to produce new emerging properties and predictable nano periodic property parameters.

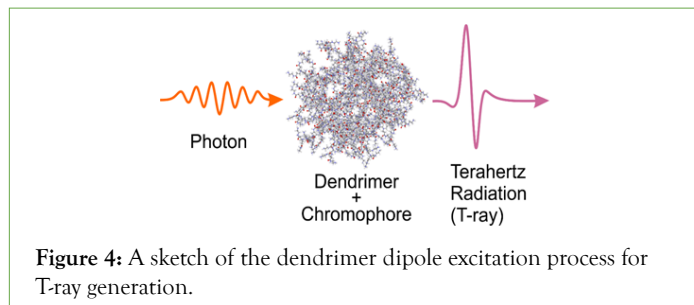

Figure 4: A sketch of the dendrimer dipole excitation process for T-ray generation.

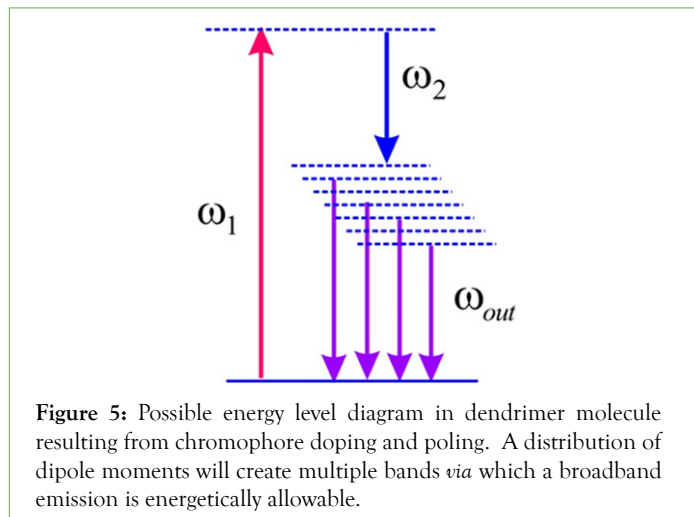

Figure 5: Possible energy level diagram in dendrimer molecule resulting from chromophore doping and poling. A distribution of dipole moments will create multiple bands via which a broadband emission is energetically allowable.

The DDE t-ray source

A time-domain spectrometer circuit was designed with the above-mentioned T-ray source as depicted in Figure 6 (a). Here only the power was measured without any samples for measuring the long-term stability. That is this power would be delivered to the sample when the measuring detector is replaced by a sample under test. For time-domain spectroscopy, which is also known as the pump-probe measurements, the circuit arrangement shown in Figure 6 (b) is used. Figure 7 displays the power output over a period of 200 ks, demonstrating very stable long-term power delivery by the source, suitable for spectroscopy applications.

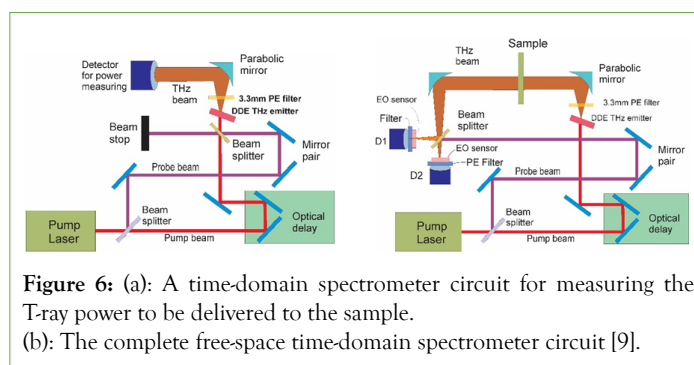

Figure 6: (a): A time-domain spectrometer circuit for measuring the T-ray power to be delivered to the sample. (b): The complete free-space time-domain spectrometer circuit [9].

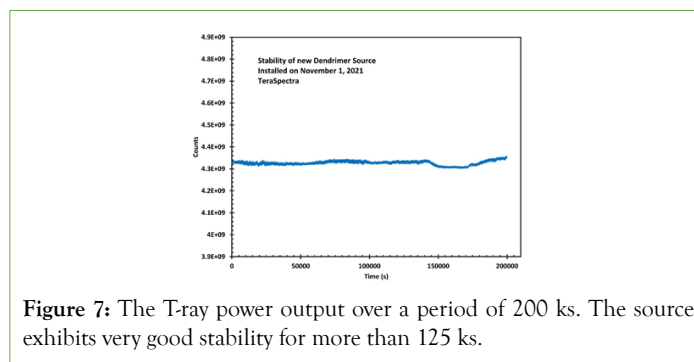

Figure 7: The T-Ray power output over a period of 200 ks. The source exhibits very good stability for more than 125 ks.

APPLICATIONS

The spectrometer circuit depicted in Figure 6 (b) has been deployed for spectral characterizations of various molecular systems. Examples include calibration with poly (ethylene), gasoline contamination [12], nanoparticle-ligand system [12]; spectral characterization of plasma spray-deposited nickel film on an alumina cylinder [13]; characterization of the vibrational states of C60, H2@C60, and D2@C60 [14]; critical evaluation of the interaction of special proteins with human stratum corneum [15]; terahertz nanosensor for rapid detection of viruses and other molecular entities [16]; and 3D Volumetric Structural Hierarchy Induced by Colloidal Polymerization of a Quantum-Dot Ionic Liquid Monomer Conjugate [17].

Therefore, it can be easily surmised that the wider window of observation offered by the DDE based T-ray technology enables discerning molecules with closely spaced masses. Simultaneously, the tunable high-power T-ray source enables the probing of a wider variety of materials and their interactions.

CONCLUSION

The DDE based T-ray source described herein is a novel technique for terahertz radiation (T-ray) generation. Here an ordinary dendrimer is converted to electro-optic dendrimer by engineering three of the possible six Critical Nanoscale Design Parameters (CNDPs). A time-domain spectrometer circuit was designed and applied for measuring the T-ray output power generated by the source after passing through the spectrometer circuit. The output power measured over a long-term (~ 200 ks) provides a proof for the stability of the DDE source. This outstanding stability over a long period is achieved by the engineered electro-optic dendrimer whose properties have been optimized to function as a non-absorbing system and not prone to photo-degradation over a long period. A time-domain spectrometer designed from this DDE source was utilized to characterize molecular identities of different molecular systems, thus proving the versatility.

REFERENCES

1. Tomalia DA. Early goddard contributions confirming the dendritic state: Engineering pamam dendrimer cndps to generate cw-terahertz radiation suitable for molecular, bio-and diagnostics imaging spectroscopy. In computational materials, chemistry, and biochemistry: From bold initiatives to the last mile. Springer Cham. 2021;935-958.
2. Siegel PH. Terahertz pioneer: David Houston. IEEE Trans Terahertz Sci Technol. 2011;1(1):6-8.
3. Simon U, Miller CE, Bradley CC, Hulet RG, Curl RF, Tittel FK, et al. Difference-frequency generation in AgGaS₂ by use of single-mode diode-laser pump sources. Opt Lett. 1993;18(13):1062-1064.
4. Shampo MA, Kyle RA, Steensma DP, Robert F. Curl Jr—Nobel laureate in chemistry. Mayo Clin Proc. 2010;85(8):e58.
5. Rahman A. Dendrimer based terahertz time-domain spectroscopy and applications in molecular characterization. J Mol Struct. 2011;1006(1-3):59-65. Rahman A, Rahman AK, Rao B. Early detection of skin cancer *via* terahertz spectral profiling and 3D imaging. Biosens Bioelectron. 2016;82:64-70.
6. Dalton LR, Sullivan PA, Bale DH. Electric field poled organic electro-optic materials: State of the art and future prospects. Chem Rev. 2010;110(1):25-55.
7. Tomalia DA. Dendritic effects: Dependency of dendritic nano-periodic property patterns on Critical Nano-scale Design Parameters (CNDPs). New J Chem. 2012;36:264-281. Pullman B. The Atom in the History of Human Thought. Oxford University Press, New York. 1998.
8. Rahman A, Rahman AK, Tomalia DA. Engineering dendrimers to produce dendrimer dipole excitation based terahertz radiation sources suitable for spectrometry, molecular and biomedical imaging. Nano scale Horiz. 2017;2(3):127-134.
9. Rahman A, Rahman AK. Dendrimer based terahertz generator. USA patents (pat.no:8050531B2), 2011.
10. Rahman A, Rahman AK, Tomalia DA. Dendrimer dipole excitation: A new mechanism for terahertz generation. J Biosens Bioelectron. 2016;7(1):1-6.
11. Rahman A, Rahman A. Wide-range broadband terahertz emission from high $\chi^{(2)}$ dendrimer. In Terahertz Technology and Applications V. 2012;8261:pp:119-124.
12. Rahman A. Terahertz spectrometry and reflectometry: A new frontier for noninvasive pico scale investigations. Spectrosc. 2013;28(2):44-53.
13. Rahman A, Tomalia DA. Terahertz spectral characterization of plasma spray-deposited nickel film on an alumina cylinder. Spectrosc. 2021;36(4):20-27.
14. Rahman A, Rahman AK, Frunzi M, Turro NJ. Vibrational states of C-60, H2@C60, and D2@C60 investigated by terahertz spectrometry. Abst No. 2011;34.
15. Crosby K, Rahman A, Crawford KF, Shariat-Madar Z, Michniak-Kohn B, Tomalia DA, et al. Critical evaluation of the interaction of special proteins with human stratum corneum *via* terahertz scanning reflectometry and spectrometry. Prec Nanomed. 2019;2(2):256-269.
16. Rahman A. NAM-PC Based terahertz nano-sensor for Rapid Detection of Viruses and Other Molecular Entities. J Membr Sci Technol. 2021;11(7):1-7.
17. Welch PM, Dreier TA, Magurudeniya HD, Frith MG, Ilavsky J, Seifert S, Rahman AK, Rahman A, Singh AJ, Ringstrand BS, Hanson CJ. 3D volumetric structural hierarchy induced by colloidal polymerization of a quantum-dot ionic liquid monomer conjugate. Macromolecules. 2020 Apr 15;53(8):2822-2833.